



Corporate

Locksmiths & Electronic Security

CL411B/BF - Black/Silver
Intelligent Bluetooth Lock

APP BT-Remote Control

For iOS and Android users, you can unlock it within 1.5s via APP "TTLock"

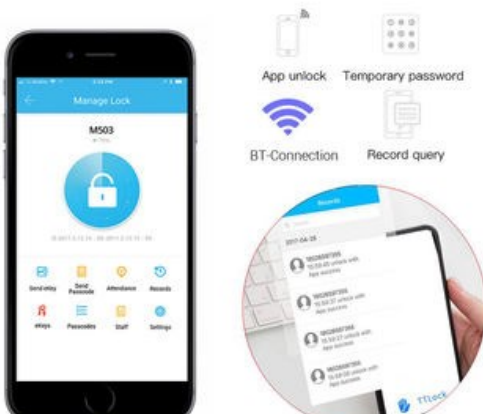

Unlock Options

- Pin Code
- Fingerprint (CL411BF Only)
- MiFare Card
- TTLock App (iOS/Android)
- Mechanical Key Override
- Gateway (sold separately)

Overview

The CL411B & CL411BF Smart Door Locks are a very versatile Keyless Digital/Electronic Door Lock. It is able to utilise most existing 60/70mm door latches.

It can be operated via Bluetooth from remote locations using the TTLock iOS/Android app without the need for Internet or WiFi. It is suited for Homes, Offices, Airbnb, Motels, Holiday Homes etc.

Specific codes can be sent via SMS or E-Mail. These codes can be temporary (1 day) or permanent.

Bluetooth access (one-time, temporary, or permanent) can also be shared by SMS or E-Mail.

An audit trail can be accessed through the app to see door access events. Many of these management actions can be performed wirelessly using a TTLock wireless gateway (sold separately)

A Micro USB port is included for power if the batteries go flat.



Corporate

Locksmiths & Electronic Security

Product Specifications

PACKING LIST:



Item no.	CL411B/CL411BF
Material	Zinc Alloy
Dimensions	270*70*20mm
Weight	3kg
Colour Options	Black, Silver
Communication mode	Bluetooth 4.0BLE (Bluetooth Low Energy)
Door Thickness Options	30-80mm
Data Capacity	500 PIN Codes, 500 MiFare Cards
Unlock time	≈ 1.5 sec
Power supply	8pcs AAA batteries
Working Temperature	-25°C - 60°C
Low Voltage Alarm	4.5V



Corporate

Locksmiths & Electronic Security

Features

1. This lock has two different models. The CL431BF is the base model with an added fingerprint reader
2. Master Bluetooth Key: The "TTLock" app can be used to open the Lock using Bluetooth.
3. Master Code: The Bluetooth lock unlocks with a permanent Master code.
4. User Code: The mobile app can generate up to 300 codes, with validity durations including One Time, Permanent, or from 5 minutes to 180 days.
5. Wrong Code Entry Limit: After 5 unsuccessful attempts at entering a code, the Bluetooth lock will be unresponsive for 5 minutes. Mechanical key and Bluetooth Unlock can be used to unlock in this state.
6. Fingerprint access can be added through the TTLock app.
7. Time Auto lock: After successfully unlocking, the Bluetooth lock will be automatically locked after a period of time (between 5 to 120 seconds). The owner sets this function.
8. Simple Locking: Press * key for 2 seconds to lock the Bluetooth lock.
9. Lower Battery Consumption: 4pcs AA batteries can provide 5000 openings
10. Lower Battery Indicator If battery power is low. it will emit low battery warning, battery level will also be updated on the app during Bluetooth unlock. If battery power runs out. Use the keys or a Micro USB cable to provide power and open the lock.
11. Decoy Code: 8 decoy digits can be entered prior to the actual code to prevent the code from being exposed.
12. The TTLock App can be used with multiple locks: Ensure you select the correct device when managing settings or adding users.

System Initialization

1. Open the cover plate of the back panel.
2. Press the "Reset" button on the back panel for 5s.
3. Press "000#", & the initialization is complete.

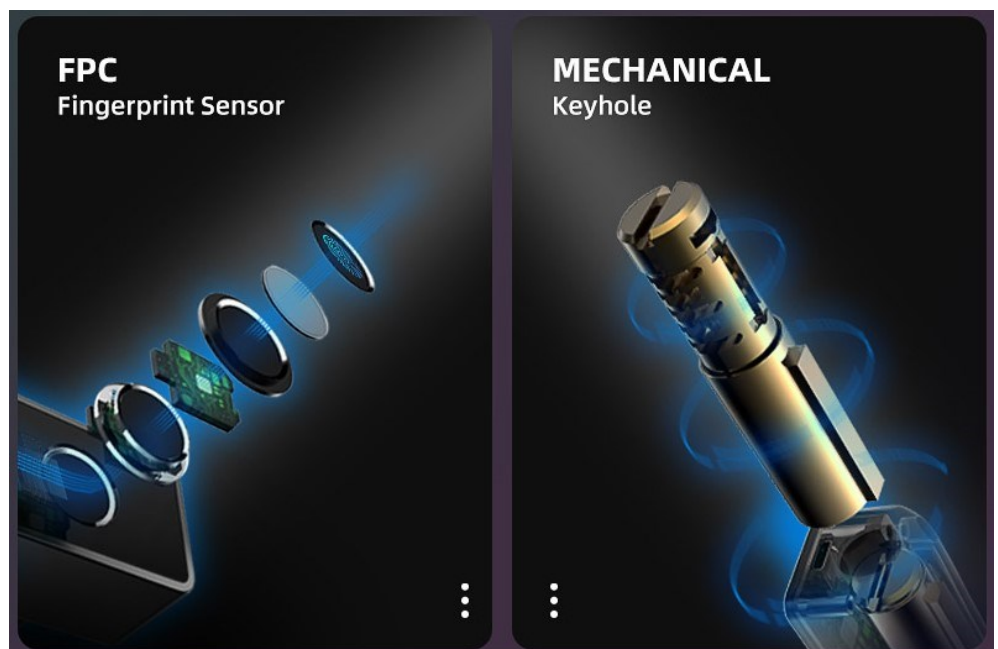



Corporate

Locksmiths & Electronic Security

Using The TTLock App





Corporate

Locksmiths & Electronic Security

Installing TTLock

Search for "TTLock" on the App Store

TTLock Cancel



TTLock
Lifestyle

OPEN

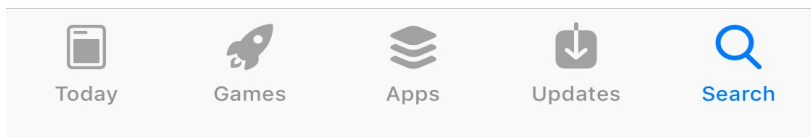
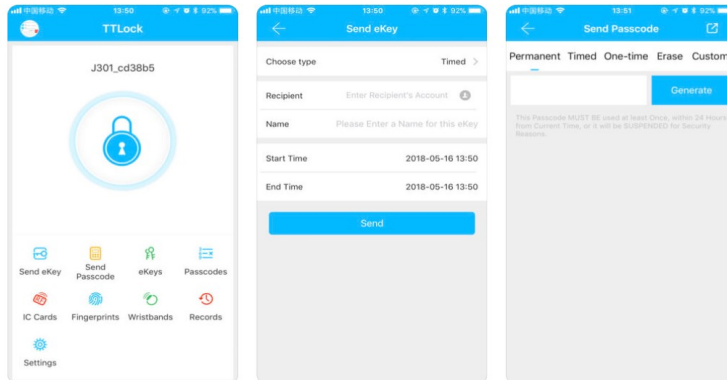

Android



Apple (iOS)





Corporate

Locksmiths & Electronic Security

Pair your device:

- 1) Touch the digital keyboard, remove one battery, touch the keyboard one more time, then put back the battery immediately.
- 2) Press the '#' button within 3-5 seconds, you will hear 'Di Di' to confirm the lock is in discovery mode.
- 3) Immediately open your app, tap the menu icon in the top-left corner, then 'add Lock', 'lock' and select your lock type from the list. Your lock will only be selectable when it's in discovery mode.
- 4) If the lock has been placed in discovery mode, it will appear on the next screen "Nearby Locks"

Changing the Admin code:

- 1) Open the TTlock app.
- 2) Select the lock you wish to change the admin code for.
- 3) Tap the 'gear' symbol in the top-right hand corner of the screen.
- 4) Tap 'Admin passcode' and follow the prompts.

Receive a text message when one of your family members arrives at home.

Sending e-Keys:

- 1) Open the TTlock app.
- 2) Select the lock you wish to authorise an eKey for.
- 3) Tap 'eKey'. Choose *period key* or *permanent key*.
- 4) Input the person's mobile number, leave a message, then tap 'send'.

Sending passcodes:

- 1) Open the TTlock app.
- 2) Select the lock you wish to authorise a passcode for.
- 3) Tap 'passcode'. Choose a validity period (one-time, minute(s), hour(s), day(s), month(s), permanent).
- 4) Tap the 'generate' button to create a code.
- 5) Tap 'Send Text Msg' to send the code to the user.

Unlock:

- 1) Open the TTlock app.
- 2) Touch digital keyboard until the backlight is on.
- 3) Listen to the doorbell tone from your phone.
- 4) Hear the lock motor disengaging the dead bolt.





Corporate

Locksmiths & Electronic Security

These steps are similar for IC Cards & Fingerprints

Fingerprint access is only available on the CL431BF model

1. Select the lock you wish to add users to.
2. Press “IC Cards” or “Fingerprints”, depending on what credential you wish to add.
3. Press the three vertical dots in the top right of the screen, and select “Add Fingerprint/IC Card”.
4. Enter a name for the credential, & specify whether it is permanent or will only work for a limited time.
5. Follow the prompts to add a fingerprint/IC Card. The software will ask you to present the card/fob to the lock, or to place your finger on the fingerprint reader multiple times.
6. Once this is complete, “Operation Successful” will show, & you will return to the first screen with the new credential added.

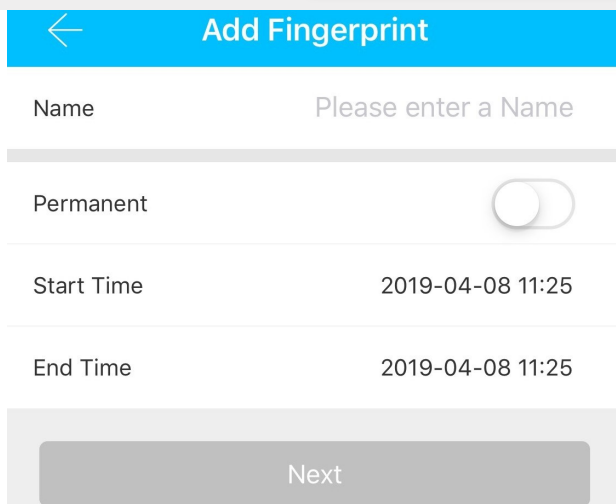
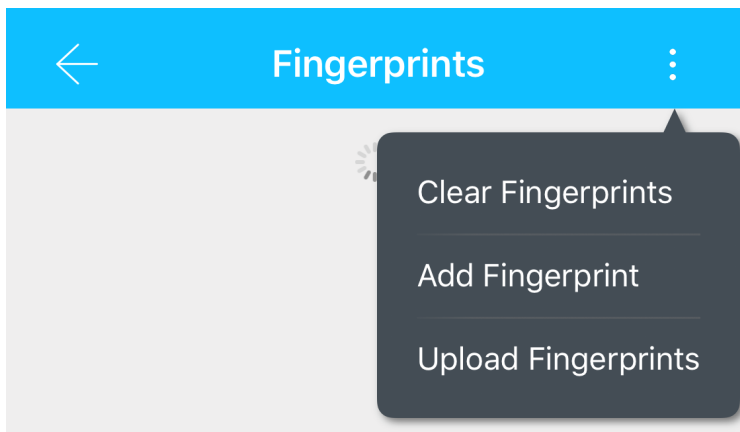
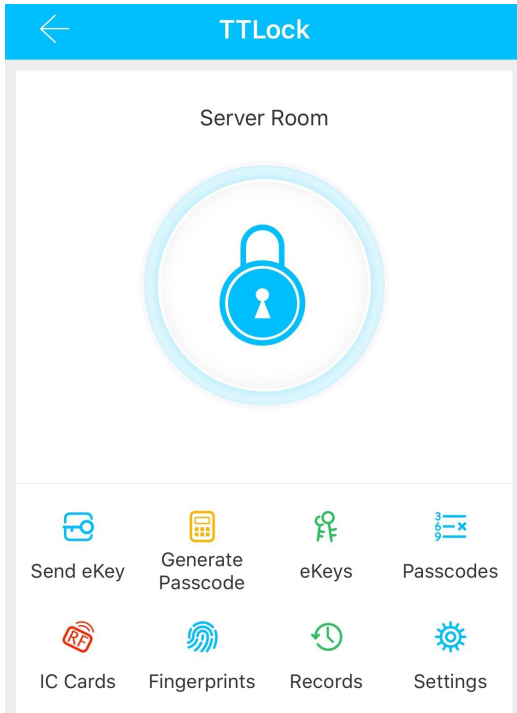



Corporate

Locksmiths & Electronic Security

Gateway Instructions

Sold Separately



When the gateway is powered on:

- Light flashes alternately in red and blue: Stand-by mode, ready for pairing
- Blue light: Working mode
- Red light: Network failure

Pair the Gateway with APP

1. Activate the APP



2. Press “≡”



4. Select [G2]



5. Plug in the gateway and power it on, while the light flashes alternately in red and blue

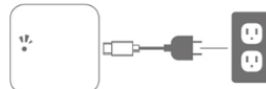

3. Select [Gateway]



6. Press “+” sign



7. Add Gateway



8. Select the network and fill in the password



9. Add complete

1. Open “TTLock” and press the menu button. ≡
2. Select the “Gateway” option, then press the “+” icon.
3. Press the “G2” Gateway option, then plug the gateway into power using the included USB-C cable.
4. Select the Wi-Fi network & enter password.
5. The gateway will then search for nearby locks.



Corporate

Locksmiths & Electronic Security

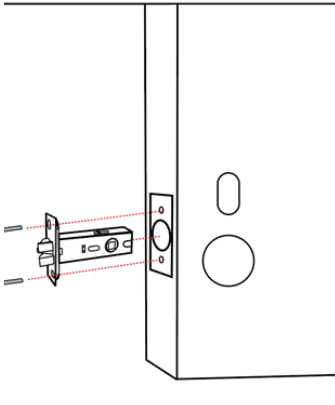
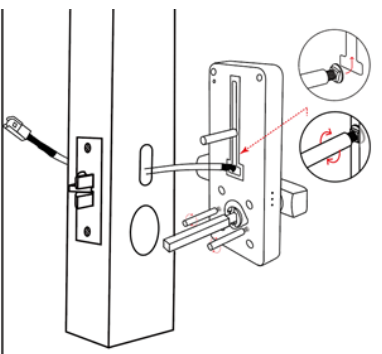
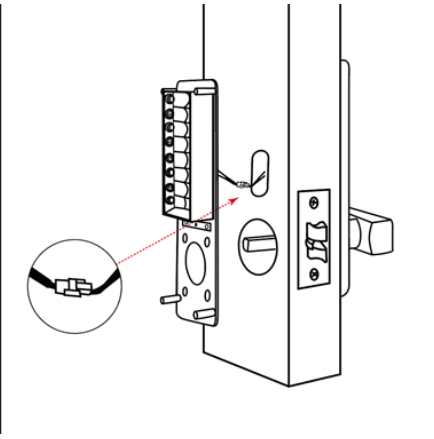
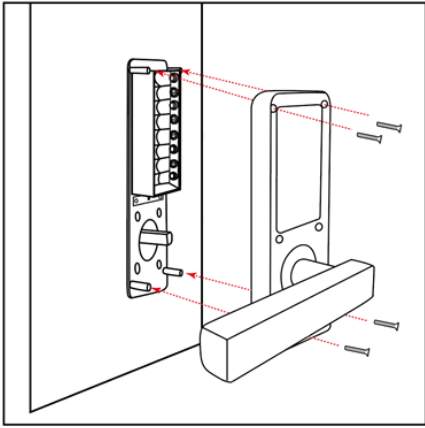
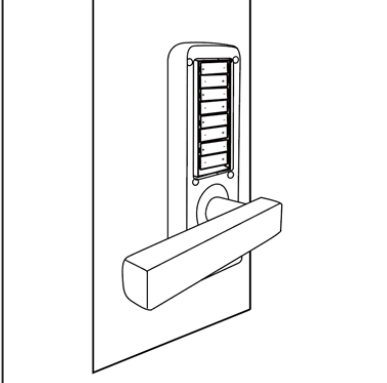
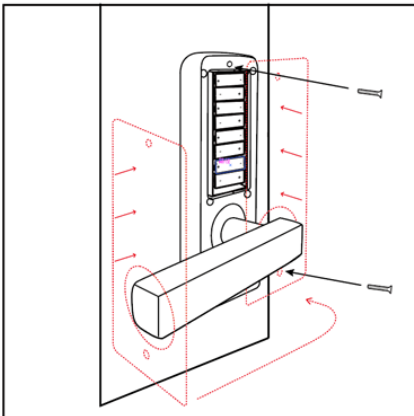
<p>Install Mortise Lock</p> 	<p>Install Sliding Screw Casing & Fixed Front Panel</p>  <p>The screw casing place is adjustable from 55mm to 100mm from the square shaft.</p> <p>Depending on the location of the hole-drilling or the old door hole.</p> <p>Keep arrow direction (shown) always upward.</p>
<p>Connect Front & Back Panels</p> 	<p>Install Back Panel</p> 
<p>Install Batteries</p> 	<p>Step 6 Install the Battery Cover</p> 



Corporate

Locksmiths & Electronic Security

Lock Handing Instructions

Notice: Adjust the handle according to the direction you open the door

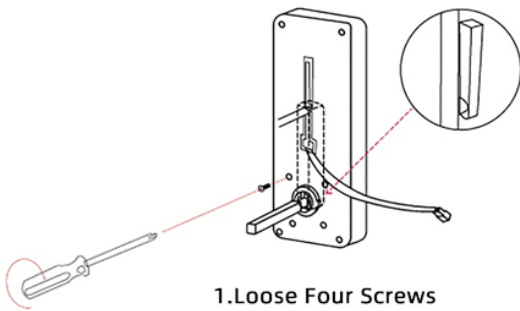

1. Loose Four Screws

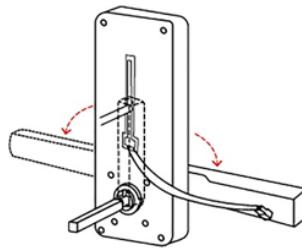

2. Left Open the Handle Toward the Left;
Right Open the Handle Toward the Right.

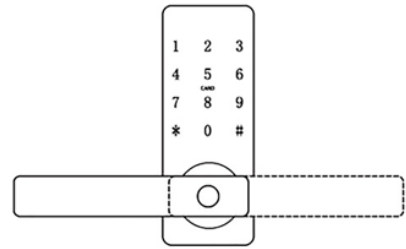

3. Reinstall the Screw After Adjusting the Direction

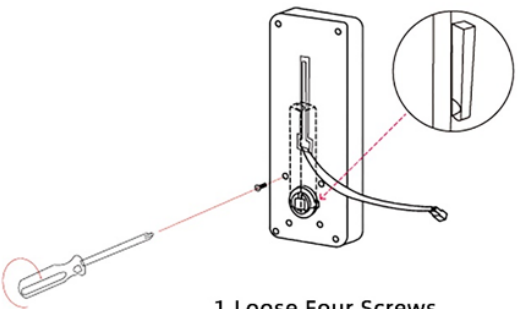

1. Loose Four Screws

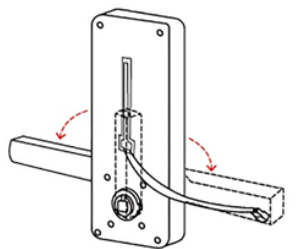

2. Left Open the Handle Toward the Left;
Right Open the Handle Toward the Right.

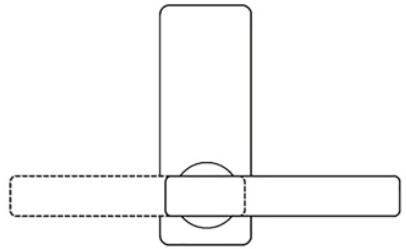

3. Reinstall the Screw After Adjusting the Direction



Corporate

Locksmiths & Electronic Security

Lock Dimensions (Not to Scale)

Handle Dimensions

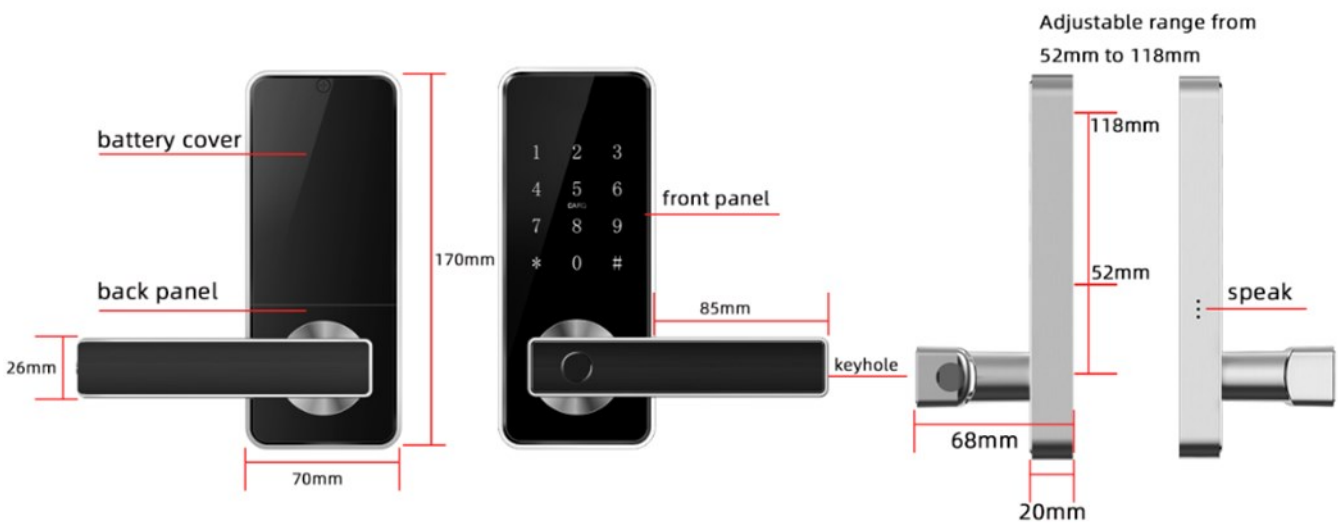

Latch Dimensions

This lock is able to work with many different latches, including typical 60mm/70mm backset latches

