

## Smart Bluetooth Fingerprint Deadbolt - CL280BF

Say goodbye to carrying your house or office key everywhere you go! Never get locked out again when you can use your fingerprint to unlock your door.

CL280BF is a smart Deadbolt that combines the best smart lock technology to provide a modern and aesthetic smart lock. Perfect for your home, work, Airbnb, Motel or office. You can set up the deadbolt to meet your needs; whether it be granting permanent, one-time or timed access, the CL280BF enables you to control access from your smartphone conveniently. This smart lock is operated via Bluetooth using the TLock iOS/Android app without the need for Internet or WiFi. The smart deadbolt can also be operated remotely when a gateway is installed alongside the smart deadbolt (Gateway Sold Separately).'

### Features:

- 5 in 1 Unlock Options (Gateway Sold Separately)
- Specific Codes can be sent via SMS or E-Mail; these codes can be temporary or permanent.
- Intelligent Alarm
- Auto Locking
- Anti-peeping Protection
- TLock, Google Assistant and Amazon Alexa are supported.
- MiFare Fobs & Fingerprints can be added as credentials.
- Mechanical Key Option
- Micro-USB port in case the batteries go flat



**TTLock Available  
on iOS & Android  
Search for "TTLock"**



### Unlock Features:

- Fingerprint
- TLock App (iOS/Android)
- MiFare Card/ Fob
- Pin Code
- Remotely via Gateway (Optional)

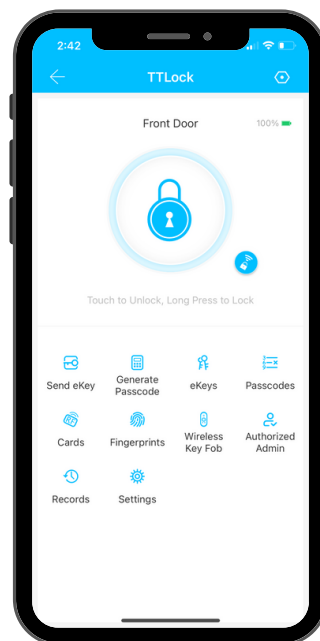



# Corporate

Locksmiths & Electronic Security

TTLock Cancel



TTLock  
Lifestyle

OPEN

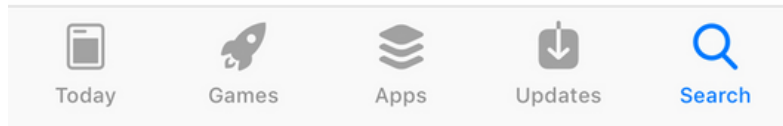
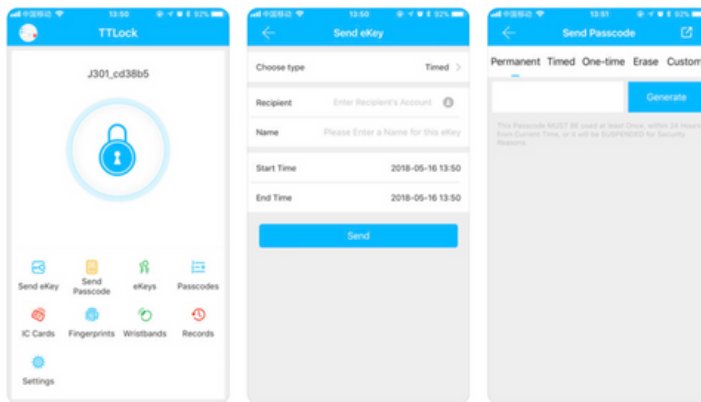

Android



Apple (iOS)



works with  
Google Assistant



WORKS WITH  
amazon alexa



# Corporate

Locksmiths & Electronic Security

## Product Specifications

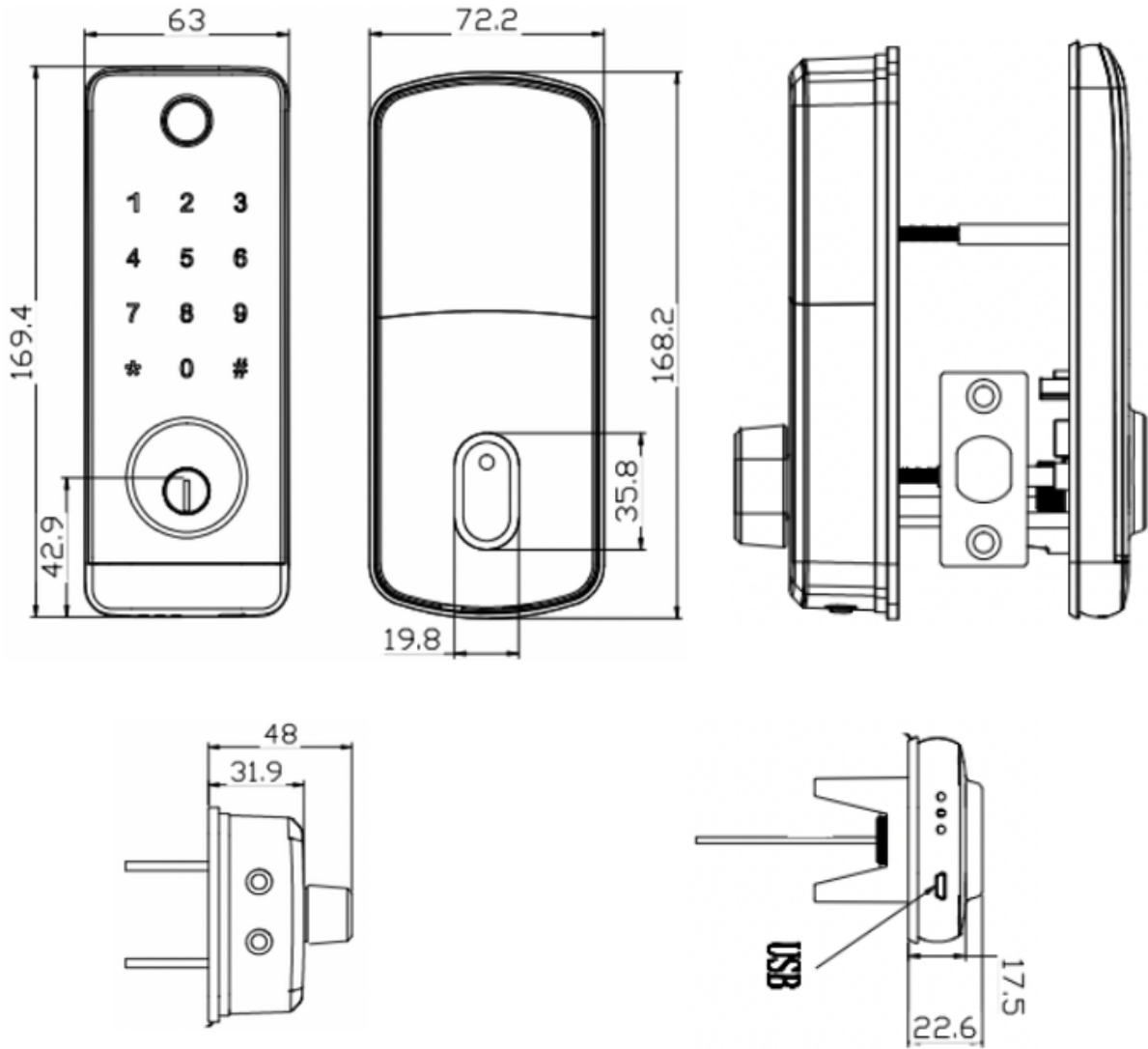

Product Code	CL280BF
Shipping Dimensions	240x200x110mm
Ingress Protection (IP) Rating	
Bluetooth Comms Distance	8 Metres (walls impede signal)
Communication Mode	BLE 4.0 (Bluetooth Low Energy)
Unlocking Options	Bluetooth, Code, MiFare Fob, Fingerprint, Remote
OS Support	iOS 9+ / Android 5+ / MacOS 11 + M1 Mac
Unlock Time	~1.5 sec
Power Supply	4x AA Batteries/6V



# Corporate

Locksmiths & Electronic Security

## Product Features



### 5 Convenient Unlock Options

- Fingerprint
- Pin Code
- Smart Phone (iOS/Android)
- MiFare Card/Fobs 13.56 Mhz
- Wireless Key Fob (Remote)
- Remotely via Gateway (Sold Separately)



# Corporate

Locksmiths & Electronic Security

## Smart Lock Set Up

### 1 Download TTLock App

Search 'TTLock' on the App Store or Google Play store & download the app.

### 2 Register & Log In

Users can register the account by email or mobile number. When registering users will receive a 'verification code' from email or mobile.

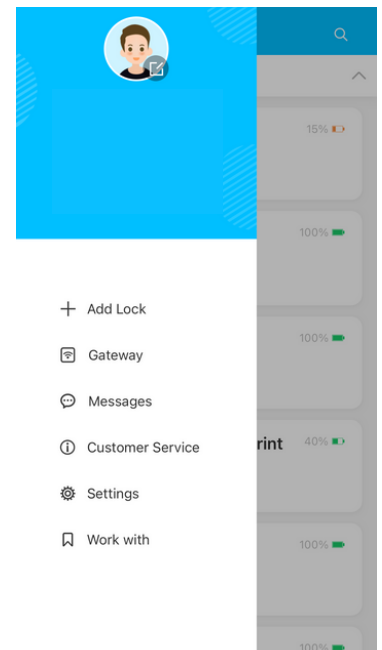
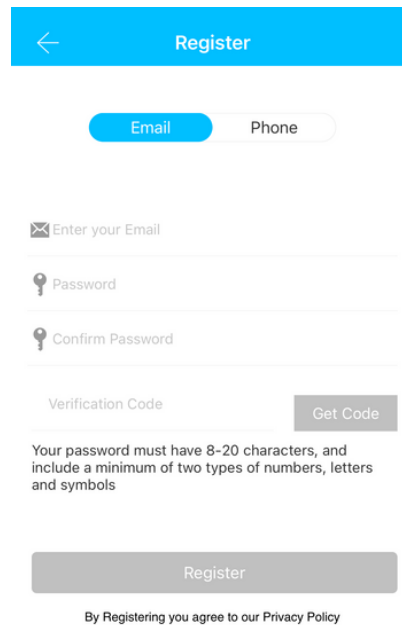

### 3 Add Device

Add the keypad by going to the menu bar in the app. Select 'Add Lock' & select 'Door Lock' or 'All Locks'

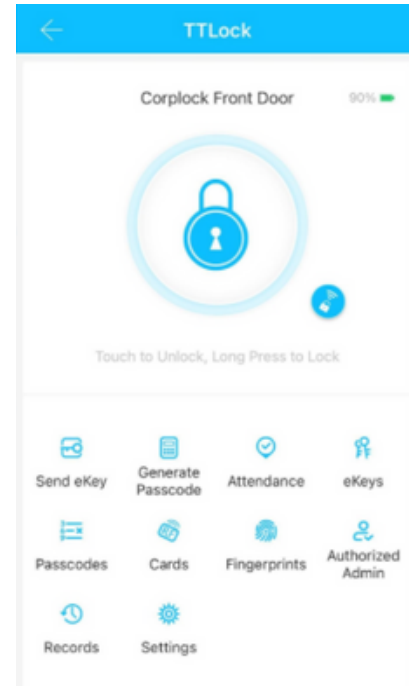
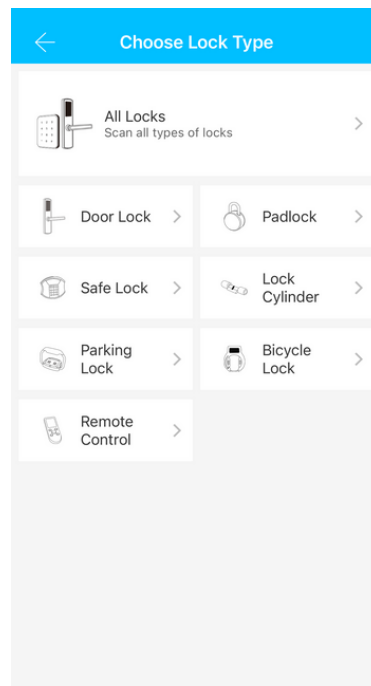

**For more in-depth resources scan the QR code below:**

